

**Montage- und Bedienungsanleitung**  
**Mounting and Operating Instructions**

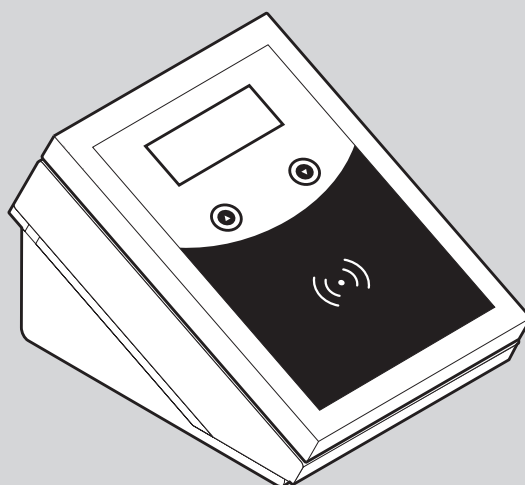

**Dialock Central Terminal CT**  
**Dialock Central Terminal CT**

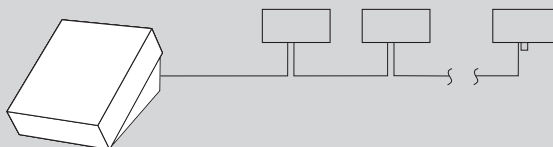

## Contents

Symbols.....	27
Safety notes.....	27
Components supplied.....	28
Field of application .....	29
Performance characteristics .....	29
Function.....	29
Installation .....	30
Electrical installation.....	31
Start-up.....	33
Operation.....	35
Menu structure .....	37
Description of function.....	38
Key menu .....	38
Cancel user key.....	39
Cancel all user keys .....	40
Closing menu .....	41
Service .....	41
Address menu .....	43
Starting up the Dialock DFT/O network .....	44
RESET.....	45
Technical data .....	46
Dimensional drawings .....	46

## Symbols



### Important

This symbol indicates passages in the instructions which must be strictly observed. Failure to comply with these passages may lead to injury or serious damage.



### Note

This symbol indicates passages which contain important information.



### Tip

These passages describe ways of making work easier.

## Safety notes



Before installing and starting the Dialock Central Terminal, read these instructions carefully (in particular the safety notes) and comply with them at all times.

Avoid misuse of the user keys by unauthorised persons. Keep the programming and cancelling keys in a safe place. These keys are essential for assigning and withdrawing user rights.

## Components supplied

- 1 Dialock Central Terminal
- 1 transformer with jack plug
- 4 self-adhering rubber buttons (Dialock Central Terminal as desktop unit)
- Terminal resistance

## Components not supplied

- Retaining plate for wall-mounting and attachment screws
- Screws with wall-plugs 3 x 50 mm
- 1 green programming keystick
- 1 red cancelling keystick
- 3 wall plugs 6 mm
- Online cable
- Y-Adapter for use with shielded, twisted pair cable

## Field of application

The Dialock Central Terminal is designed for simple central administration of user keys for the Dialock Furniture Terminal DFT/O.

With the Dialock Central Terminal, administration of up to 50 DFT/O is possible. This means that it is no longer necessary to assign and cancel user keys at each individual DFT/O.

## Performance characteristics

- Central administration of user keys
- Central approval and locking of all connected DFT/Os
- Self-surveillance of all connected DFT/Os
- Easy installation and start-up

## Function

In combination with Dialock Furniture Terminals DFT/O the Dialock Central Terminal is a network of scanning units. The use of user keys is assigned or withdrawn centrally at the Dialock Central Terminal.

## Installation



Do **not** connect the transformer to the network.

### Preparation

Select a safe location for the Dialock Central Terminal.



If using several Dialock Central Terminals, observe a minimum clearance of 25 cm. Otherwise malfunctions may occur.

English

### Desktop unit

When using the Dialock Central Terminal as a desktop unit, apply the rubber buttons to protect the surface.

### Wall installation

Mount the retaining plate at a suitable height on the wall. The location should be as convenient as possible and easily accessible for use.

Drill three holes for attachment of retaining plate and insert wall plugs.

Screw the plate into position using the screws provided.

Drill holes ( $\varnothing$  2 mm) in the housing for the securing screws.

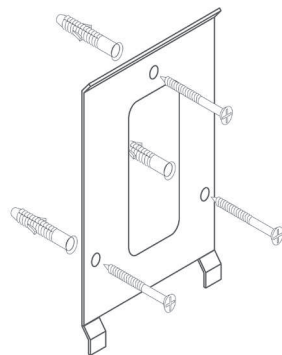

Fig. 1

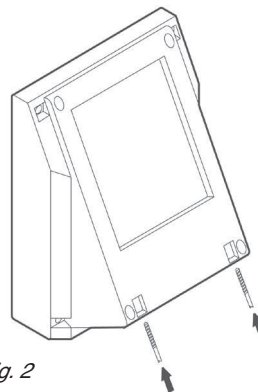

Fig. 2

## Electrical installation



Use only the power unit supplied. Failure to comply may cause irreparable damage to the Diallock Central Terminal.

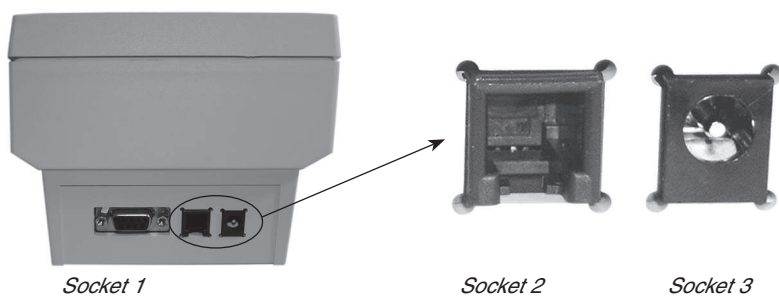

Fig. 3

Plug the power unit into the power supply. Do not insert jack plug into socket 3 yet.

### Network

Insert the Western plug (RJ10) of the pre-assembled data cable (910.51.095; 910.51.096; 910.51.097; 910.51.098) into socket 2 of the Diallock Central Terminal and connect the socket „Data in“ to the first Diallock DFT/O.

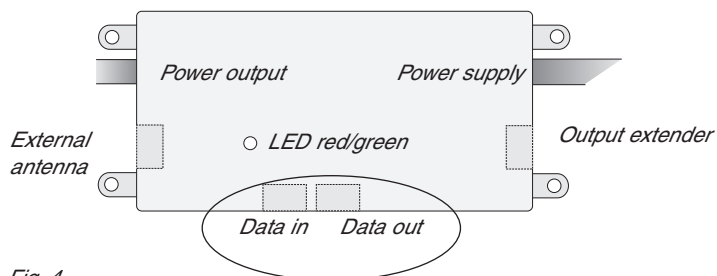

Fig. 4

With another data cable, connect the „Data out“ socket of the DFT/O to „Data in“ socket of the second DFT/O. Other DFT/Os are connected in the same way. The maximum number of DFT/Os in one network is 50.

At the last DFT/O, insert the terminal resistance into the „Data out“ socket. The terminal resistance is supplied with the Diallock Central Terminal. If this is not plugged in, malfunctions may occur.

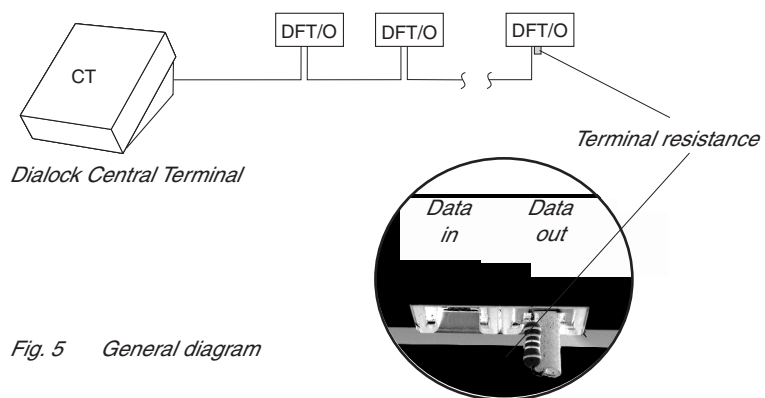

Fig. 5 General diagram



## Start-up



The first start-up is only possible immediately following the first application of the power supply with the power unit provided, or following a RESET. Until the first start-up has been successfully completed, the unit returns to first start-up mode every time power is applied to it.

### First start-up

Carry out the first start-up in one continuous procedure without interruption.

1. Keep the green programming key and the red cancelling key at the ready.
2. Apply power by inserting the jack plug into socket 3 (page 31, fig. 3).  
⇒ The following signal appears for a maximum of 5 sec.

```
*****  
Prog. Key  
Present Key  
*****
```

3. Within these 5 sec. hold the green programming key at a distance of approx. 3 cm from the scanner of the Dialock Central Terminal. The scanner is marked by the following symbol:



If the green programming key is not held in front of the scanner within this time, the first set-up mode is ended automatically. Disconnect the Dialock Central Terminal from the power supply and repeat the first start-up procedure from the beginning.

The following signal appears in the display:

```
*****  
Key learned,  
Remove Key  
*****
```

4. Remove the green programming key.

⇒ The following signal appears:

```
*****  
Clear Key,  
Present Key  
*****
```

5. Hold the red cancelling key in front of the scanner.

⇒ Following successful assignment, the following signal reappears:

```
*****  
Key learned,  
Remove Key  
*****
```

6. Remove the red cancelling key.

⇒ The following signal appears:

```
*****  
Dialock  
Central Online  
*****
```

The Dialock Central Terminal is now ready for operation.

## Operation

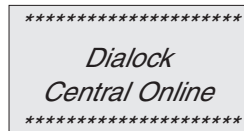

Fig. 6 Display



Fig. 7 Operating panel

The Dialock Central Terminal has a four-line display (fig. 6) and two buttons for operation (fig. 7).

Following the first start-up, the various menus can be displayed by holding the programming key in front of the scanner. The desired menu is selected with the left-hand button and confirmed with the right-hand button.

In each case, the function of the key appears in the bottom line of the display. E.g. left-hand button = scroll key list, right-hand button = cancel key.



**The menu „Teach keys“ is selected directly by holding the programming key in front of the scanner a second time. The menu „Cancel keys“ can also be selected directly without pressing a button by holding the cancelling key in front of the scanner a second time.**

If approx. 10 seconds elapse without a key being pressed, the system switches back automatically to the basic function.

### Scanning field

For the correct operation of the Dialock Central Terminal, the keys have to be held inside the scanning field of the Dialock Central Terminal. The scanning field is marked with the following symbol:



### Basic function

In its basic function, the Dialock Central Terminal shows the number of the user key currently held in front of it.

Example:

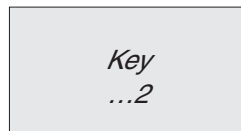

**Following successful first start-up, set the language for the display messages.**

**To improve administration, keep a list of users. Enter each user in the list along with the relevant key number.**

## Menu structure

### Main menu

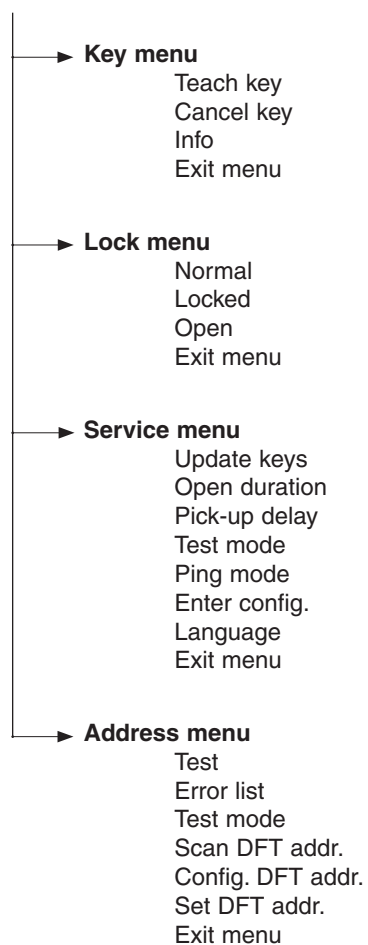

## Description of function

### Key menu

#### Teach user key

Select menu: Key menu / teach key

1. Hold programming key in front of scanner.
2. Select „Key menu“ (press right-hand button).
3. Select „Teach key“ (press right-hand button).

⇒ The following message appears:

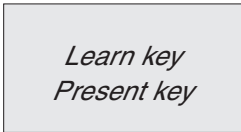

*Learn key  
Present key*

4. Hold user key in front of scanner.

⇒ The following message appears:



*Key x learned*

(X stands for the next free number in the key list)



**To improve administration, keep a user list. Enter each user with his key number. It is possible to cancel a user key using the key number only without possessing the user key (e.g. due to loss, theft etc.).**

### Cancel user key

Select menu: Key menu / cancel key.

1. Hold programming key in front of scanner.
2. Select „Key menu“ (press right-hand button).
3. Select „Cancel key“ (press right-hand button).
4. Cancelling user key.

#### **Cancelling existing user key:**

- a. Hold user key in front of scanner.
- b. Cancel the key finally by pressing left-hand button (yes).

Opening and closing rights have now been withdrawn from this key.

English

### Alternative procedure

#### **Cancelling by selection from the key list:**

- a. With the left-hand button select the key to be cancelled.
- b. Confirm selection by pressing right-hand button (cancel).
- c. Request for confirmation if selected user key is to be cancelled.
- d. Press left-hand button (yes) to cancel selected user key finally.

Opening and closing rights have now been withdrawn from this key.

### Cancel all user keys

1. Hold the red cancelling key in front of the scanner of the Dialock Central Terminal.
  2. Hold the green programming key in front of the scanner of the Dialock Central Terminal.
  3. Press the left-hand button (yes) to cancel all keys finally.
- Opening and closing rights have now been withdrawn from all user keys.

English



**Opening and closing rights are withdrawn without any further warning.**



## Closing menu

The following closing procedures are available:

### Normal (manufacturer's setting)

By selecting this menu item and following sub-menus, the connected Dialock Furniture Terminals DFT/O are set so that the components to be operated (lock housings, FLCs) are unlocked when an authorised user key is held up. The duration of the unlocked period is determined by the open time.

### Locked

By selecting this menu item and following sub-menus, the connected Dialock Furniture Terminals DFT/O are permanently locked. It is not possible to open them with a user key.

### Unlocked

By selecting this menu item and following sub-menus, the connected Dialock Furniture Terminals DFT/O are permanently unlocked. It is not possible to lock them with a user key.

## Service

### Update keys

This function transfers the user-key list to all the connected Dialock Furniture Terminals DFT/O. This function can be executed when a DFT/O is added or replaced.

### Duration of opening

When this function is selected, the value set for the open time appears in the display. With the left-hand button, the value can be set between 0 and 30 sec. If the value 0 is set, the DFT/O operate in the „Bolt-lock function“ mode.

In the Bolt-lock function mode, the connected lock is opened by operating the DFT/O with a valid key. It remains open (voltage applied) until the key is again held in front of the DFT/O.

### **Pick-up delay (only DFT Tag-it™ ISO)**

When this function is selected, the value set for the pick-up delay appears in the display. With the left-hand button, the value can be set between 0 and 10 sec. This function serves to delay the activation of the connected locking points by the time value set.

### **Test mode**

This mode makes it possible to check communication between the Dialock Central Terminal and the connected Dialock Furniture Terminals DFT/O. When this function is selected, the LED on the Dialock Furniture Terminals DFT/O flashes alternately red and green. If this does not happen, check the wiring and the connected terminals.

### **Ping mode**

This mode is for checking the bi-directional communication between the Dialock Central Terminal and a DFT/O. For this purpose, the DFT/O must be set with a special transponder „SETDOOR“ (#7) to address 121. The Dialock Central Terminal records the responses / errors.

### **Enter config.**

This function is for entering the configuration from another central terminal or a DFT/O.

### **Language**

This function permits the selection of the language for the Dialock Central Terminal. The following languages are available:

- Deutsch
- English
- Français
- Español
- Italiano

## Address menu

When the address menu is selected, the following sub-menus are available:

### Test

This test checks all the DFT/Os with currently assigned addresses. After conclusion of the test, the number of errors is indicated. If errors have occurred, all the addresses are indicated along with the number of errors which have occurred.

### Error list

The error list, the currently assigned addresses of the DFT/Os are listed with the errors which have occurred during operation. The error counter can be reset when the menu is exited.

### Test mode

Using this menu item, it is possible to activate or deactivate the automatic test mode. When the test mode is activated, the link to all the configured DFT/Os can be tested every 60 minutes. Errors are entered in the error list.

### Scan DFT Addr.

This function cancels all the stored addresses and updates the address list with all the participants (DFT/O) connected to the bus in the address range 1 to 64.

### DFT addr. config.

This function cancels all the stored addresses and starts the automatic addressing mode. The Dialock Central Terminal assigns an address to a connected DFT/O when the special transponder „SETDOOR“ (#7) is read by the DFT/O. It starts automatically with address 1 and increases by 1 for each DFT/O added. Successful addressing is signalled at the DFT/O by two short bleeps.

### Set DFT addr.

This function is for addressing a specific DFT/O.



**The address is not added to the address list of the Dialock Central Terminal.**

## Starting up the Dialock DFT/O network

### 1. Essential conditions for starting the DFT/O network up:

- a) All the DFT/Os are installed and receiving power.
- b) All the DFT/Os are interconnected in the network (see page 31).
- c) The terminal resistance is set (see page 31).
- d) The Dialock Central Terminal is installed and connected with the network.
- e) The Central Terminal has been successfully started up (page 33).

### 2. Addressing the networked Dialock DFT/O

- a) Hold the programming key in front of the scanner of the Central Terminal.
- b) Using the scrolling key, select the menu Address. and confirm with the right-hand button (OK).
- c) Using the scrolling key, select the function „DFT config. addr.“ and confirm with the right-hand button (OK).
- d) The Central Terminal begins with address no. 01.
- e) With the special transponder SETDOOR (hex 07) go to the DFT/O which is to receive the first address. Hold special transponder SETDOOR in front of the antenna of the DFT/O. When the transponder is reading, a single bleep is given for confirmation. A double bleep is given following successful address assignment.  
If no double bleep is heard, check the wiring of this DFT/O.
- f) The other DFT/Os are addressed as described in 2e.
- g) When all the DFT/Os are addressed, conclude the process on the Central Terminal by pressing the button „End“.
- h) The Central Terminal now indicates how many DFT/Os have been addressed.
- i) Press „Continue“ to return to the Address menu.
- j) To test the system, now select the function „Test“. The Dialock Central Terminal now tests the link with the addressed DFT/Os and records any errors in the error list. The number of errors is indicated by the Central Terminal after concluding the test.

- k) If errors have occurred, switch to the error list (Address. menu).  
This lists the addresses of the DFT/Os to which the link has failed.  
Check the connection to these DFT/Os and after solving the problem, repeat the test until it is completed with no further errors.
- l) The addressing procedure is now concluded.

### **3. Teaching the user keys**

The user keys can now be taught. Proceed as described on page 38.  
After conclusion of the teaching process, the keys taught are transferred automatically to all the DFT/Os in the network.

## **RESET**

Resetting the hardware of the Dialock Central Terminal can only be done by an authorised technician.

## Technical data

Voltage supply	
DC voltage	10 – 12 VDC
AC voltage	8 – 9 VAC
Current consumption	200 mA
IP protective system	IP 30
Temperature range	0° C – 60° C
Relative humidity (non condensing)	0 – 95%

English

## Dimensional drawings

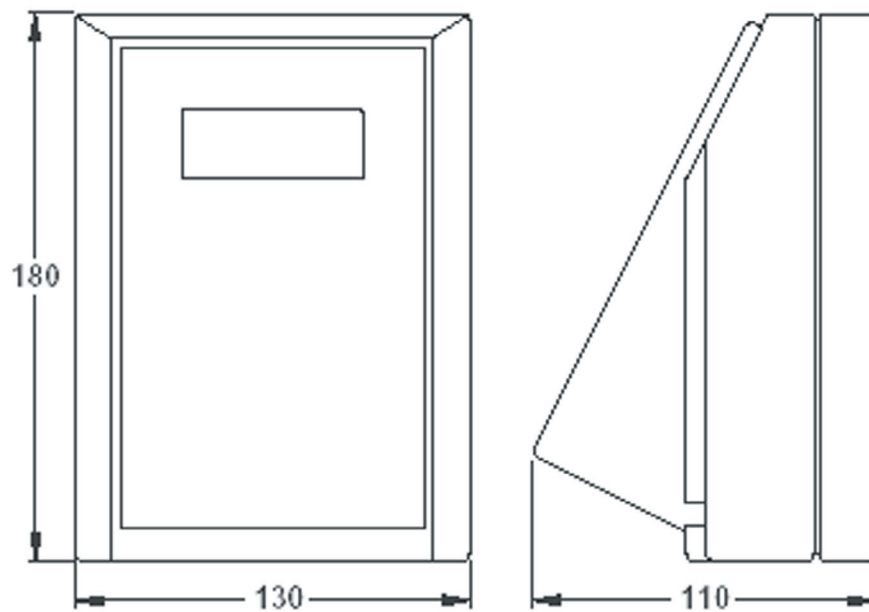



## Copyright

Ⓓ Der Nachdruck dieses Dokuments, auch auszugsweise, oder die Nachahmung der Abbildungen und Zeichnungen sowie die Nachahmung der Gestaltung sind verboten. Für Druckfehler und Irrtümer, die bei der Erstellung der Montageanleitung unterlaufen sind, ist jede Haftung ausgeschlossen. Liefermöglichkeiten und technische Änderungen vorbehalten.  
Stand: 07.2006

Ⓒ The reprint of this document, even extracts, or copying of the illustrations and drawings as well as copying of the layout are prohibited. No liability is accepted for printing errors or errors occurred during the creation of the mounting instructions. We reserve the right for technical changes and changes of availability.  
Status 07.2006

Art. no.: 732.29.198

Sphinx Electronics GmbH & Co KG  
Tullastraße 3  
D-79341 Kenzingen

Support: (+49) 74 52 / 9 52 84  
Email: dialock@haefele.de